

Patented  
Technology

# EDC SERIES

1500VA - 2200VA



## High Efficiency Double Conversion UPS with Power Conditioner

- Integrated Power Conditioner
- Extended Battery Module Capability
- Built-in Power Factor Correction
- Pure Sine Wave Output with 0.9 Power Factor
- Adjustable LED Display
- Rack or Tower Configuration
- Real-time Voltage & Frequency Regulation - Generator Compatible

### Advanced Overload Protection

- Multiple overload level detection allows for extended time of uninterrupted operation during various stages of overloading.
- Automatic switching to BYPASS mode for additional time of uninterrupted operation.

### Realtime Network Monitoring and Notifications

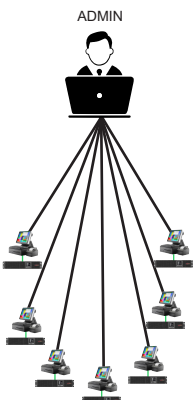

- Remote management and configuration via Web Browser, NMS
- Event logging to trace the operation's history
- Graphic data logging to analyze power conditions
- Event notifications via Email, SNMP traps
- It has the ability to set up for an alert when the battery is in need of replacement
- Supports Environmental Sensor (optional) advanced Enterprise power management software
- Power ON/OFF, reboot, and on demand battery testing for UPS.



### LCD Panel

- Easy-to-read LCD display provides information about power conditions
- The LCD display will show how much time is left before the UPS will turn back on or shut down
- Unit can be controlled via LCD display and via network card web console.
- LCD can be easily rotated via software.
- Displays various information in detail, such as load levels in VA or WATT, backup time at current load, battery pack voltage, etc.

Designed for:





- Critical server
- Network
- AV Systems
- Telecommunications equipment

# EDC SERIES

## FEATURES

- Integrated Power Conditioner for Protection against Common Mode, Normal Mode, Ground Loop Interferences
- High efficiency On-Line double Conversion / pure sine wave output design
- Fully informative LCD display to show power loads and UPS stats
- Automatic voltage regulator (AVR and battery backup in one unit)
- Short circuit and overload protection with automatic bypass capability
- Power management software with network monitoring capability with diagnostic and battery check
- Gigabit Network surge protection circuit
- HID USB and Smart RS232 communications port
- User replaceable UPS battery
- UPS can power on with or no batteries
- SNMP network management capability
- EPO (Emergency Power Off) capable
- Two year warranty - Optional extended warranty

## PROTECTION AGAINST...

-  Blackouts - With battery backup
-  High and low voltage surges (disruptive surges and interferences) - With TBF™ technology
-  Under or over voltage/frequency fluctuations - With double conversion regulation
-  Lightning or other high voltage anomalies - With surge protection
-  Reduces the need for truck-rolls

## FRONT/REAR PANEL DESCRIPTION

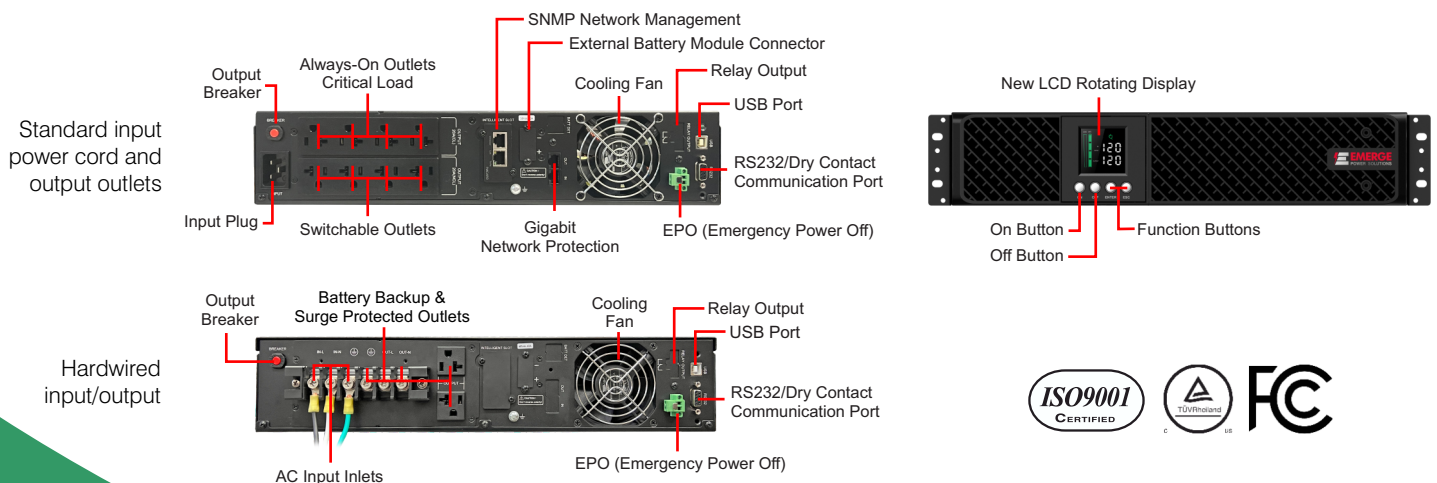

800-882-8285

7409 Railhead Ln. • Houston, TX 77086  
Tel: 713-464-8000 Fax: 713-984-0841  
Email: sales@emergepowersolutions.com

**EMERGE™**  
POWER SOLUTIONS

SMART POWER SYSTEMS

www.emergepowersolutions.com

# Specifications

MODEL	EDC1500RT-T	EDC2200RT-T / EDC2200RT-THW
Capacity (VA / Watts)	1500VA / 1350W	2200VA / 1980W
Energy-Saving Technology	Yes, ECO Mode Efficiency $\geq 95\%$	
<b>Input</b>		
Input Voltage Range	55~150Vac	
Input Frequency Range	50/60Hz	
Input Power Factor	0.99	
Cold Start	Yes	
UPS Inlets	IEC C14	IEC C20 / Hard Wire Terminal
<b>Output</b>		
Output Waveform	Pure Sine Wave	
Output Voltage	100, 110, 115, 120, 127Vac $\pm 1\%$ *	
Output Frequency	50/60Hz (Auto-Sensing or Configurable) $\pm 0.5\text{Hz}$ **	
Line Mode Voltage Regulation	$\pm 1\%$	
ECO Mod Voltage Regulation	$\pm 10\%$ , $\pm 15\%$ (Configurable)	
Crest Factor	3:1	
Harmonic Distortion	THD < 3% at Linear Load, THD < 6% at Non-linear Load	
UPS Outlets	(8) NEMA 5-15	(8) NEMA 5-20R ((4) Remote Switchable Set)/ Terminal+(2) NEMA 5-20R
Transfer Time (Typically)	0ms	
<b>Battery</b>		
Model - Voltage	EP015 - 36VDC (Sealed, Maintenance Free)	EP022 - 48VDC (Sealed, Maintenance Free)
Run Time (Half Load)	12 Minutes	
Recharge Time (Typically)	4 Hours (inside batteries)	
<b>Protection</b>		
Power Conditioning	Power Conditioning Protection against Common Mode, Normal Mode, Ground Loop Interferences	
Overload Protection	Line Mode	105%~110% Warning, transfer to bypass after 10min; 110%~130% Warning, transfer to bypass after 1min; >130% Warning, transfer to bypass after 3s.
	Battery Mode	105%~110% Warning, shut down after 6min; 110%~130% Warning, shut down after 1min; >130% Warning, shut down after 3s.
	Bypass Mode	110%~120% Warning, shut down after 30min; 120%~130% Warning, shut down after 10min; >130% Warning, shut down after 1min.
Short Circuit Protection	UPS Output Cut off Immediately or Input Fuse / Circuit Breaker Protection	
<b>Management</b>		
LCD Screen	Graphic LCD	
Connectivity Ports	(1) Serial Port (RS232), (1) USB Port	
Emergency Power OFF (EPO)	Yes	
Audible Alarms	Battery Mode, Battery Low, Overload, UPS Fault, Replace Battery, Bypass Mode Charger Failure / Over Charged, Fan failure, EPO active	
Power Management Software	PowerMaster	
SNMP / HTTP Capable	(1) Expansion Port (With optional card)	
<b>Environment</b>		
Operating Temperature	0C to 40C	
Operating Relative Humidity	20% to 90% Non-Condensing	
<b>Physical</b>		
Dimensions (W x D x H) (in.)	17.24 x 16.93 x 3.46	
Net Weight (Lbs.)	15.40	44.85
Altitude	<2000m	

Specification are subject to change without notice.

(\*) Within 50/60Hz $\pm 8\%$  by default, the output frequency is synchronization with input mains. User can adjust the acceptable range for output frequency ( $\pm 1, 2, 3, 4, 5, 6, 7, 8, 9, 10\%$ ). When input frequency is out of synchronization window but within 40-70Hz, UPS can stay in line mode and output frequency is regulated at 50/60Hz $\pm 0.5\%$  with load derating by 40%.

